

ecocirc XL 50-80 F

Technical data

Company name
Contact
Phone number
e-mail address

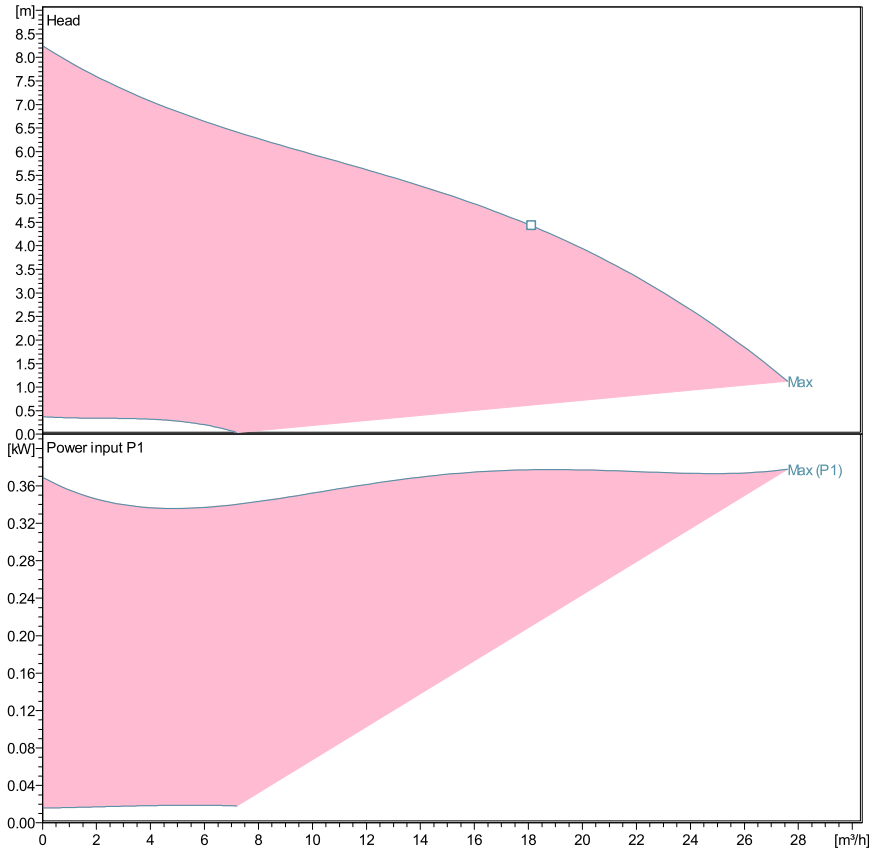

Performance according to ISO 9906:2012 – Grade 3B
Liquid temperature:
-10°C (14°F) to +110 °C (230°F) for heating pumps
-10°C (14°F) to +85 °C (185°F) for domestic hot water pumps
Power data referred to:
Water [100%]: 4°C; 1000kg/m³; 1.57mm²/s



Pump data

Make	Lowara
Port to port (mm)	240
Electrical connection	Terminals
Specific EEI	<= 0,23
Nominal pressure	PN 6/10
Connection	Flanged / DN 50

Electrical data

Rated voltage	230 V
Frequency	50 / 60
Protection class	IP 44
Insulation class	F
Digital input	Contact load: 5V, 10 mA
Digital output	Vmax < 250 VAC / Imax < 2 A
Analog input	0-10 V / 4-20 mA
Leakage current	< 3.5 mA
Communication capabilities	No communication protocol
Sound pressure level	<= 48 dB(A)
Rated current	1.7 A

Materials

Bush Bearing	Carbon, resin impregnated	Impeller	PPS
Thrust bearing	Aluminium	Wear ring	Stainless steel
Bearing plate	Stainless steel	Rotor can	Stainless steel
Motor housing	Aluminum	Shaft	Stainless steel
O-rings	EPDM	Control box	Poly carbonate
PUMP HOUSING	Cast Iron		

Dimensions mm

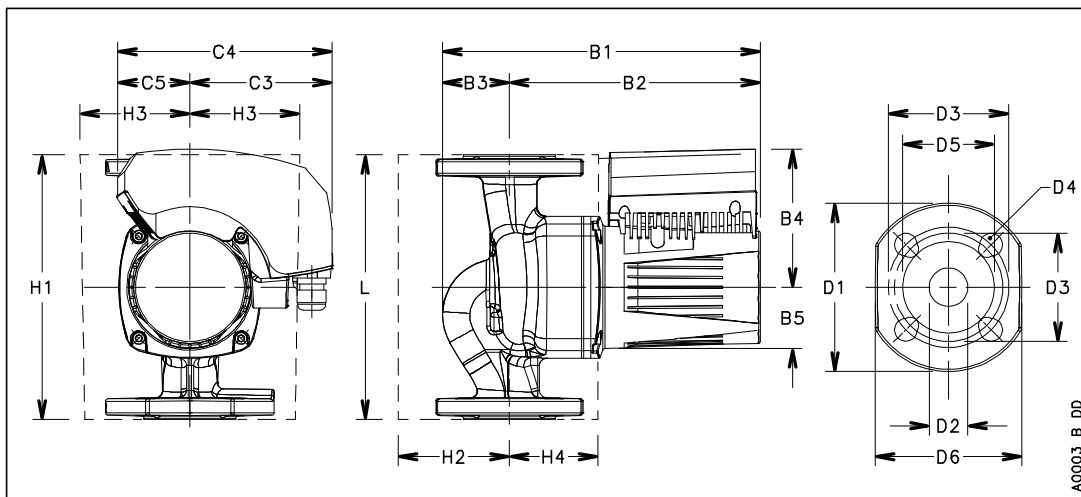

B1	355
B2	261
B3	94
B4	132
B5	53
C3	128
C4	206
C5	78
D1	465
D2	50
D3	110/125
D4	4 x 14/19
D5	100
G	DN 50
Gross Weight	19.7
H1	230
H2	93
H3	93
H4	93
L	240
Net Weight	15.9