

MSL, MSV, SV Series

Safety valves

Technical Data Sheet



Description

MSL, MSV and SV Series safety valves automatically discharge enough liquid to ensure that the safety pressure setpoint is not exceeded. They protect the boiler and system, and require no energy except the pressurised fluid.

The valves are designed and manufactured in compliance with "R" regulations - 2009 edition, applied technical specifications of Italian Ministerial Decree 1-12-1975.

MSL



Diaphragm safety valve. **1/2" MF connections.**

CW617N brass body. Technopolymer manual discharge knob.

Ni-Cr steel spring.

Fluids: water with glycol \leq 50%.

Operating temperature: -10 to 110°C.

WRAS compliant.

Compliant with PED 2014/68/EU Identification number CE1115.

| Type | Part No. | DN | bar | Weight (g) |
|------|----------|------|-----|------------|
| MSL | 0206015N | 1/2" | 1,5 | 150 |
| MSL | 0206018N | 1/2" | 1,8 | 150 |
| MSL | 0206020N | 1/2" | 2 | 150 |
| MSL | 0206525 | 1/2" | 2,5 | 150 |
| MSL | 0206530 | 1/2" | 3 | 150 |
| MSL | 0206035N | 1/2" | 3,5 | 150 |
| MSL | 0206540 | 1/2" | 4 | 150 |
| MSL | 0206050N | 1/2" | 5 | 150 |
| MSL | 0206060N | 1/2" | 6 | 150 |
| MSL | 0206070N | 1/2" | 7 | 150 |
| MSL | 0206080N | 1/2" | 8 | 150 |
| MSL | 0206090N | 1/2" | 9 | 150 |
| MSL | 0206099N | 1/2" | 10 | 150 |

MSV



Diaphragm safety valve. **1/2" FF connections.**

CW671N brass body. Technopolymer manual discharge knob.

Ni-Cr steel spring.

Fluids: water with glycol \leq 50%.

Operating temperature: -10 to 110°C.

WRAS compliant.

Compliant with PED 2014/68/EU Identification number CE1115.

| Type | Part No. | DN | bar | Weight (g) |
|------|----------|------|-----|------------|
| MSV | 0207015N | 1/2" | 1,5 | 150 |
| MSV | 0207018N | 1/2" | 1,8 | 150 |
| MSV | 0207020N | 1/2" | 2 | 150 |
| MSV | 0207525 | 1/2" | 2,5 | 150 |
| MSV | 0207530 | 1/2" | 3 | 150 |
| MSV | 0207035N | 1/2" | 3,5 | 150 |
| MSV | 0207540 | 1/2" | 4 | 150 |
| MSV | 0207050N | 1/2" | 5 | 150 |
| MSV | 0207060N | 1/2" | 6 | 150 |
| MSV | 0207070N | 1/2" | 7 | 150 |
| MSV | 0207080N | 1/2" | 8 | 150 |
| MSV | 0207090N | 1/2" | 9 | 150 |
| MSV | 0207099N | 1/2" | 10 | 150 |

SV



Diaphragm safety valve. CW617N brass body.
Technopolymer manual discharge knob. Ni-Cr steel spring.
Rubber diaphragm and seal resistant to 110°C.
FF connections with larger outlet.

TÜV approved.

Compliant with PED 2014/68/EU Identification number CE1115.

| Type | Part No. | DN | bar | Weight (g) |
|------|----------|---------------|-----|------------|
| SV | 0216015N | 1/2" x 3/4" | 1,5 | 200 |
| SV | 0216018N | 1/2" x 3/4" | 1,8 | 200 |
| SV | 0216020N | 1/2" x 3/4" | 2 | 200 |
| SV | 0215125 | 1/2" x 3/4" | 2,5 | 200 |
| SV | 0215130 | 1/2" x 3/4" | 3 | 200 |
| SV | 0216035N | 1/2" x 3/4" | 3,5 | 200 |
| SV | 0215104 | 1/2" x 3/4" | 4 | 200 |
| SV | 0216045N | 1/2" x 3/4" | 4,5 | 200 |
| SV | 0216050N | 1/2" x 3/4" | 5 | 200 |
| SV | 0216055N | 1/2" x 3/4" | 5,5 | 200 |
| SV | 0216060N | 1/2" x 3/4" | 6 | 200 |
| SV | 0216070N | 1/2" x 3/4" | 7 | 200 |
| SV | 0216080N | 1/2" x 3/4" | 8 | 200 |
| SV | 0216090N | 1/2" x 3/4" | 9 | 200 |
| SV | 0216099N | 1/2" x 3/4" | 10 | 200 |
| SV | 0217015N | 3/4" x 1" | 1,5 | 270 |
| SV | 0217018N | 3/4" x 1" | 1,8 | 270 |
| SV | 0217020N | 3/4" x 1" | 2 | 270 |
| SV | 0217625 | 3/4" x 1" | 2,5 | 270 |
| SV | 0217630 | 3/4" x 1" | 3 | 270 |
| SV | 0217035N | 3/4" x 1" | 3,5 | 270 |
| SV | 0217604 | 3/4" x 1" | 4 | 270 |
| SV | 0217045N | 3/4" x 1" | 4,5 | 270 |
| SV | 0217050N | 3/4" x 1" | 5 | 270 |
| SV | 0217055N | 3/4" x 1" | 5,5 | 270 |
| SV | 0217060N | 3/4" x 1" | 6 | 270 |
| SV | 0217070N | 3/4" x 1" | 7 | 270 |
| SV | 0217080N | 3/4" x 1" | 8 | 270 |
| SV | 0217090N | 3/4" x 1" | 9 | 270 |
| SV | 0217099N | 3/4" x 1" | 10 | 270 |
| SV | 0218615 | 1"x1.1/4" | 1,5 | 660 |
| SV | 0218625 | 1"x1.1/4" | 2,5 | 660 |
| SV | 0218630 | 1"x1.1/4" | 3 | 660 |
| SV | 0218604 | 1"x1.1/4" | 4 | 660 |
| SV | 0218305 | 1"x1.1/4" | 5 | 660 |
| SV | 0218606 | 1"x1.1/4" | 6 | 660 |
| SV | 0218607 | 1"x1.1/4" | 7 | 660 |
| SV | 0218608 | 1"x1.1/4" | 8 | 660 |
| SV | 0218610 | 1"x1.1/4" | 10 | 660 |
| SV | 0219615 | 1.1/4"x1.1/2" | 1,5 | 860 |
| SV | 0219625 | 1.1/4"x1.1/2" | 2,5 | 860 |
| SV | 0219630 | 1.1/4"x1.1/2" | 3 | 860 |
| SV | 0219604 | 1.1/4"x1.1/2" | 4 | 860 |
| SV | 0219405 | 1.1/4"x1.1/2" | 5 | 860 |
| SV | 0219606 | 1.1/4"x1.1/2" | 6 | 860 |
| SV | 0219607 | 1.1/4"x1.1/2" | 7 | 860 |
| SV | 0219608 | 1.1/4"x1.1/2" | 8 | 860 |
| SV | 0219610 | 1.1/4"x1.1/2" | 10 | 860 |

IS



Exposed drain funnel for safety and thermal drain valves.

| Type | Part No. | DN | Weight (g) |
|------|----------|-----------|------------|
| IS | 0235115 | 1/2" FF | 270 |
| IS | 0235120 | 3/4" FF | 400 |
| IS | 0235125 | 1" FF | 600 |
| IS | 0235132 | 1.1/4" FF | 1000 |

| Technical features | |
|-----------------------|---------------------------|
| Nominal pressure | PN10 |
| Overpressure | <10% |
| Blowdown | <15% (MSL, MSV) <20% (SV) |
| Operating temperature | -10 to 110°C |
| PED class | IV |

| Materials | |
|-----------------------|--------------------------|
| Body | CW617N brass |
| Diaphragm | EPDM |
| Manual discharge knob | technopolymer |
| Setting spring | Ni-Cr steel |
| Cap and disc | reinforced technopolymer |

Certifications

CE mark

MSL, MSV and SV Series safety valves meet the requirements of the Pressure Equipment Directive 2014/68/EU. The valves are classified in category IV, considered the highest risk category, given that they are safety devices and bear the CE mark followed by the number 1115, identifying the approval authority.

See the individual model descriptions for other approvals (UDT, AFNOR, TÜV).

In accordance with EN1491, the maximum power of the boiler on the basis of the diameter is:

| Size | 1/2" = DN15 | 3/4" = DN20 | 1" = DN25 | 1.1/4" = DN32 |
|-------------|-------------|-------------|-----------|---------------|
| Power | 75kW | 150kW | 250kW | 350kW |
| Max. Volume | 200 l | 1,000 l | 5,000 l | > 5000 |

Application

MSL, MSV and SV Series safety valves are generally used in closed-loop heating systems with rated power of less than 35kW that use hot water at temperatures below 110°C, and in plumbing systems to protect hot water storage. The safety valve protects the generator or the storage tank from sudden, unexpected pressure surges.

Therefore, the safety valve remains inoperative when the system is operating normally.

Operation

The fluid in the system exerts pressure on the disc, which pushes against the spring until the pressure exceeds the declared setting. The disc then slowly starts to open, allowing the water flow to inflate the diaphragm.

The valve opens and discharges into the air, relieving the system from dangerous pressure for the boiler and system components.

The disc opens fully before the fluid pressure exceeds the pressure setpoint by 10% (**overpressure**).

The valve closes before the pressure drops to 15% less than the setpoint pressure (**blowdown**).

On **SV Series** valves, the outlet port has a wider diameter than the inlet port, increasing the discharge capacity of the valve.

The characteristics of the materials prevent the valves from seizing as a result of ageing.

MSV series

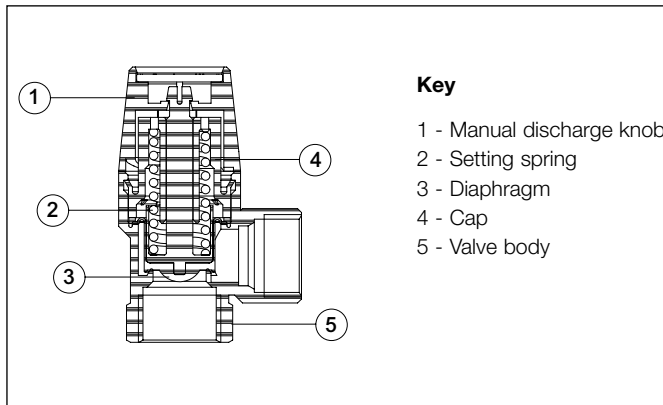

MSL series

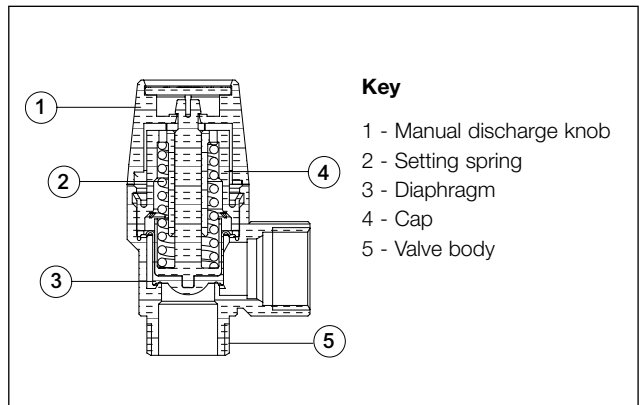

SV series

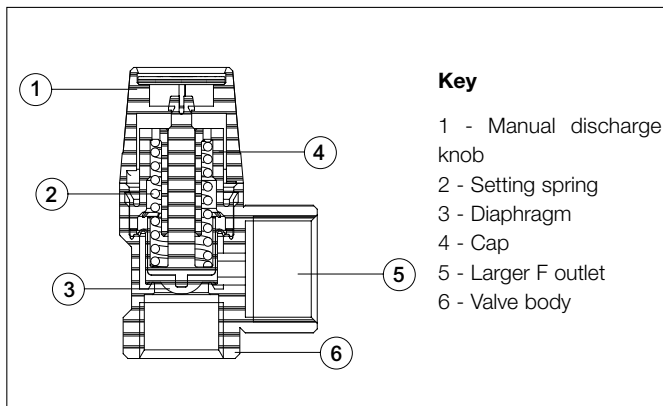

Sizing

Safety valves designed for use with **heating systems**, where no experimental determination is carried out are defined as standard valves. In the calculation formula for these valves, the value of 0.9K, i.e. equal to 0.05 (R.2.A) should be assumed. The regulations thus drastically reduce the application limit for standard safety valves in the heating field. However, systems with rated power of less than 35 kW (30,000 kcal/h) are not subject to the regulations covered by Italian Ministerial Decree 1.12.1975.

$$W = \frac{0.9 \times A \times K}{0.005 \times F}$$

where:

- A = net valve orifice section in cm²
- F = factor inferred from Table 2 in "R" Regulations (R.2.A.2.3)
- W = steam venting capacity in kg/h

For **plumbing systems**, "R" Regulations indicate the sizing criterion for safety valves to be used in protecting domestic boilers. The orifice of these safety valves should have a diameter (D), with a minimum of 15 mm, of no less than:

$$D_{min} = \sqrt{V/5}$$

where:

- D = net valve orifice diameter in mm
- V = volume of boiler in litres

These valves must be set to a pressure not exceeding the maximum permissible boiler pressure, and connected directly without shut-off devices.

| | Setting pressure | Max. discharge pressure | Min. discharge pressure | Orifice diameter | Orifice section | Discharge coeff. | Discharge flow rate | Max. rated power of boiler | |
|----------------|------------------|-------------------------|-------------------------|------------------|--------------------|------------------|---------------------|----------------------------|----------|
| | (bar) | (bar) | (bar) | (mm) | (cm ²) | (K) | (kg/h) | (kW) | (kcal/h) |
| MSL/MSV | | | | | | | | | |
| 1/2" | 1,5 | 1,65 | 1,35 | 13,50 | 1,43 | 0,57 | 97 | 56 | 48.500 |
| | 1,8 | 1,98 | 1,62 | | | | 109 | 63 | 54.250 |
| | 2 | 2,2 | 1,8 | | | | 117 | 68 | 58.250 |
| | 2,5 | 2,75 | 2,25 | | | | 135 | 78 | 67.250 |
| | 3 | 3,3 | 2,7 | | | | 153 | 89 | 76.250 |
| | 3,5 | 3,85 | 3,15 | | | | 172 | 100 | 85.750 |
| | 4 | 4,4 | 3,6 | | | | 191 | 111 | 95.000 |
| | 5 | 5,5 | 4,5 | | | | 226 | 131 | 112.750 |
| | 6 | 6,6 | 5,4 | | | | 262 | 152 | 130.750 |
| | 7 | 7,7 | 6,3 | | | | 300 | 174 | 149.500 |
| | 8 | 8,8 | 7,2 | | | | 342 | 198 | 170.250 |
| | 9 | 9,9 | 8,1 | 377 | 218 | 187.750 | | | |
| | 10 | 11 | 9 | 408 | 237 | 203.500 | | | |
| SV | | | | | | | | | |
| 1/2"X3/4" | 1,5 | 1,65 | 1,35 | 13,50 | 1,43 | 0,57 | 97 | 56 | 48.500 |
| | 1,8 | 1,98 | 1,62 | | | | 109 | 63 | 54.250 |
| | 2 | 2,2 | 1,8 | | | | 117 | 68 | 58.250 |
| | 2,5 | 2,75 | 2,25 | | | | 135 | 78 | 67.250 |
| | 3 | 3,3 | 2,7 | | | | 153 | 89 | 76.250 |
| | 3,5 | 3,85 | 3,15 | | | | 173 | 100 | 86.250 |
| | 4 | 4,4 | 3,6 | | | | 191 | 111 | 95.000 |
| | 4,5 | 4,95 | 4,05 | | | | 210 | 122 | 104.750 |
| | 5 | 5,5 | 4,5 | | | | 226 | 131 | 112.750 |
| | 5,5 | 6,05 | 4,95 | | | | 245 | 142 | 122.000 |
| | 6 | 6,6 | 5,4 | | | | 262 | 152 | 130.750 |
| | 7 | 7,7 | 6,3 | | | | 300 | 174 | 149.500 |
| | 8 | 8,8 | 7,2 | | | | 342 | 198 | 170.250 |
| | | 9 | 9,9 | | | | 8,1 | 377 | 218 |
| | 10 | 11 | 9 | 408 | 237 | 203.500 | | | |
| 3/4"X1" | 1,5 | 1,65 | 1,35 | 14,00 | 1,54 | 0,66 | 121 | 70 | 60.500 |
| | 1,8 | 1,98 | 1,62 | | | | 135 | 79 | 67.500 |
| | 2 | 2,2 | 1,8 | | | | 145 | 84 | 72.500 |
| | 2,5 | 2,75 | 2,25 | | | | 168 | 97 | 83.750 |
| | 3 | 3,3 | 2,7 | | | | 190 | 110 | 95.000 |
| | 3,5 | 3,85 | 3,15 | | | | 215 | 125 | 107.250 |
| | 4 | 4,4 | 3,6 | | | | 238 | 138 | 118.500 |
| | 4,5 | 4,95 | 4,05 | | | | 261 | 152 | 130.250 |
| | 5 | 5,5 | 4,5 | | | | 281 | 163 | 140.250 |
| | 5,5 | 6,05 | 4,95 | | | | 305 | 177 | 152.000 |
| | 6 | 6,6 | 5,4 | | | | 327 | 189 | 162.750 |
| | 7 | 7,7 | 6,3 | | | | 373 | 216 | 186.250 |
| | 8 | 8,8 | 7,2 | 425 | 247 | 212.000 | | | |

| | | | | | | | | | |
|---------------|-----|-----|-----|------|------|------|------|-----|---------|
| 1"X1.1/4" | 1,5 | 1,7 | 1,4 | 20,5 | 3,3 | 0,84 | 330 | 192 | 164.750 |
| | 2,5 | 2,8 | 2,3 | | | | 458 | 266 | 228.250 |
| | 3 | 3,3 | 2,7 | | | | 520 | 301 | 259.250 |
| | 4 | 4,4 | 3,6 | | | | 648 | 376 | 323.250 |
| | 5 | 5,5 | 4,5 | | | | 768 | 445 | 382.750 |
| | 6 | 6,6 | 5,4 | | | | 891 | 517 | 444.250 |
| | 7 | 7,7 | 6,3 | | | | 1018 | 591 | 507.750 |
| | 8 | 8,8 | 7,2 | | | | 1160 | 673 | 578.750 |
| | 10 | 11 | 9 | | | | 1386 | 804 | 691.250 |
| 1.1/4"X1.1/2" | 1,5 | 1,7 | 1,4 | 27,5 | 5,94 | 0,49 | 347 | 201 | 173.000 |
| | 2,5 | 2,8 | 2,3 | | | | 481 | 279 | 239.750 |
| | 3 | 3,3 | 2,7 | | | | 546 | 317 | 272.250 |
| | 4 | 4,4 | 3,6 | | | | 680 | 395 | 339.250 |
| | 5 | 5,5 | 4,5 | | | | 806 | 467 | 402.000 |
| | 6 | 6,6 | 5,4 | | | | 936 | 543 | 466.500 |
| | 7 | 7,7 | 6,3 | | | | 1069 | 620 | 533.250 |
| | 8 | 8,8 | 7,2 | | | | 1218 | 707 | 607.500 |
| | 10 | 11 | 9 | | | | 1455 | 844 | 725.750 |

Installation

MSL, MSV and SV Series safety valves must be installed in accordance with the flow direction indicated by the arrow on the valve body.

The valves may be mounted horizontally or vertically as long as the discharge funnel is not facing upwards and is positioned so that the discharge cannot cause damage to property or injury to people.

The factory setting pressure of the safety valves is non-adjustable. The setting is indicated on the tag at the top of the manual discharge knob.

The valve discharge pipe must be visible and routed to a funnel (see **IS Series**) or receptacle, and facilitate inspection in the event of opening.

It should not be possible to shut off the connecting pipework between the safety valve and the boiler, nor should the section of this pipework be at any point less than the safety valve inlet port section.

To ensure perfect efficiency, the safety valves require regular inspection.

Over time, foreign matter may build up close to the disc; therefore the valve seat should be flushed periodically (e.g. at the start of the heating season). It can be flushed through manual discharge of the valve by turning the knob in the direction of the arrows. Almost all leaks (dripping, incomplete closing) are caused by impurities lodged between the seat and disc; therefore, periodic inspection and flushing prevent these leaks and any ensuing problems.

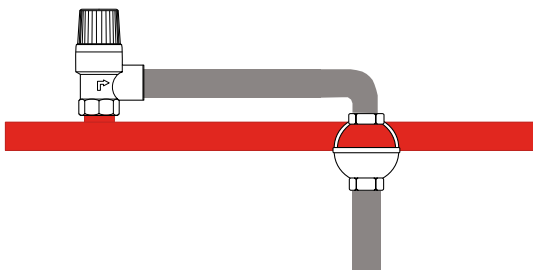

Fig.1
Direct installation of the funnel on the discharge pipework

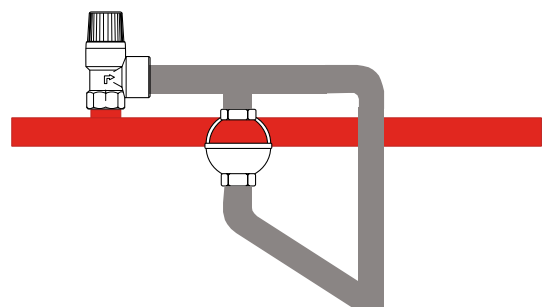
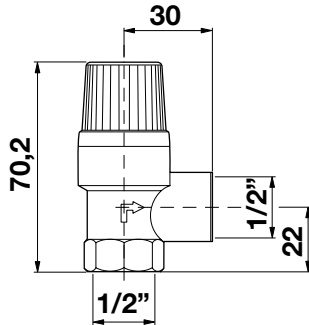

Fig.2
Common installation of the funnel where the discharge flow rate is high

Overall dimensions (mm)

MSL/MSV



SV

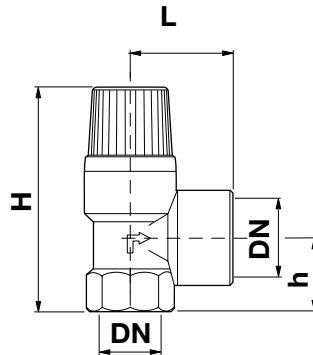

| DN | L | H | h |
|-----------------|----|------|------|
| 1/2" x 3/4" | 34 | 72,7 | 24,5 |
| 3/4" x 1" | 37 | 84,2 | 34 |
| 1" x 1.1/4" | 55 | 189 | 40 |
| 1.1/4" x 1.1/2" | 60 | 204 | 43 |

IS

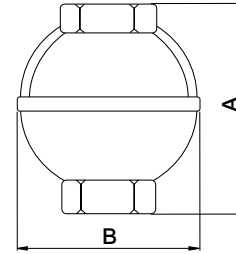

| DN | A | B |
|--------|-----|----|
| 1/2" | 61 | 45 |
| 3/4" | 65 | 57 |
| 1" | 78 | 68 |
| 1.1/4" | 113 | 97 |

Specification text

MSL series

Diaphragm safety valve **MSL Series** – WATTS brand – with pressure setting from 1.5 to 10 bar. CW617N brass body. Technopolymer manual discharge knob. Ni-Cr steel spring. Operating temperature range: -10 to 110°C. With added glycol: 50% 1/2" MF connections WRAS approved. Compliant with 2014/68/EU Identification number CE1115.

MSV series

Diaphragm safety valve **MSV Series** – WATTS brand – with pressure setting from 1 to 10 bar. CW617N brass body. Technopolymer manual discharge knob. Ni-Cr steel spring. Operating temperature range: -10 to 110°C. With added glycol: 50% 1/2" FF connections WRAS approved. Compliant with 2014/68/EU Identification number CE1115.

SV series

Diaphragm safety valve **SV Series** – WATTS brand – with pressure setting from 1.5 to 10 bar. CW617N brass body. Technopolymer manual discharge knob. Ni-Cr steel spring. Rubber diaphragm and seal resistant to 110°C. 1/2" - 1.1/4" FF connections with larger outlet. TÜV approved. Compliant with 2014/68/EU Identification number CE1115.

IS Series

Exposed brass drain funnel **IS Series** – WATTS brand – for safety and thermal drain valves. Diameters from 1/2" to 1 1/4" with FF connections.

The descriptions and photographs contained in this product specification sheet are supplied by way of information only and are not binding.

Watts Industries reserves the right to carry out any technical and design improvements to its products without prior notice. Warranty: All sales and contracts for sale are expressly conditioned on the buyer's assent to Watts terms and conditions found on its website at www.wattsindustries.com. Watts hereby objects to any term, different from or additional to Watts terms, contained in any buyer communication in any form, unless agreed to in a writing signed by an officer of Watts.

WATTS[®]

Watts Industries Italia S.r.l.

Via Brenno, 21 • 20853 Biassono (MB) • Italy
Tel. +39 039 4986.1 • Fax +39 039 4986.222
infowattsitalia@wattswater.com • www.watts.com